

OmniGV

Multipurpose, heavy duty bin lift for 120L to 10CBM containers

The OmniGV has been developed to offer the most diverse and capable lifter in the Terberg range, built strong to allow it to operate faultlessly in some of the harshest environments in the world.

The OmniGV's robust, innovative design makes it perfectly suited to handling household and industrial waste regardless of the container.

The multipurpose lifter is perfectly capable of handling a wide variety of containers from 120 liter wheeled containers all the way up to 10 cubic meter skips.

■ Flexibility;

The modular approach used for the OmniGV affords waste and recycling collection organisations maximum flexibility with regards to different collection contracts and the ability to adapt the RCV to handle the various container types that are involved.

■ Construction;

With typical Terberg robust construction the OmniGV will last in environments where extremes of temperature, humidity and dust presence can create problems for lesser capable equipment. The OmniGV includes Hardox® steel plate work which helps allow it to lift and easily tip, heavy loaded large containers.

The multi-functional tilting frame gives great usability and is compatible with Terberg / AMCS Bin Weighing systems.

■ Skip lifting;

The OmniGV can tip 5 to 10 cubic meter containers conforming to DIN30720 by the use of 4 chains. The unique OmniGV design allows a safe working lifting capacity of 7 tonnes on an RCV.

■ Trunnion option;

Trunnion arms can be added at any time to handle 4-wheel flat lid & dome lid containers compliant with EN840-2 and EN840-3 respectively.

■ Pocket arm option;

Additionally, pocket arms to handle 4-wheel, 2.5 and 4.5 cubic meter containers conforming to DIN30738/EN12574 can be added whenever the capability is required.

■ Comb lifting option;

As an option the OmniGV bin lift can be supplied with a comb and clamp mechanism to allow handling of EN840.1 & EN840.2 containers.

■ Very easy operation;

OmniGV has a Terberg Compact Controller with electric levers (finger joystick control) for smooth & safe operation.

The OmniGV is very simple and easy to operate.

■ Visibility (option);

The optional integrated LED rear light and indicator units allow the RCV to be highly visible during movements at night and in busy traffic.

■ Footboard (option);

The OmniGV is available with folding footboards and handrails.

■ Designed with dynamic weighing in mind;

The OmniGV is designed as standard to accept AMCS / Terberg Weighing system load cells.

See our VDH9013 Weighing and VDH6012 RFID brochures for further information.



OmniGV

●-standard ○-option ○-not available

Technical Specifications

OmniGV

Heavy duty bar tilting frame

Terberg Compact Controller for lift and Hydraulic Lever for lid opener

Lifting configuration >

Control system >

Terberg Weighing & RFID preparation >

EN840.1 containers (80-390 litres)
by comb lifting >

EN840.2 containers (500-1200 litres)
by DIN pick up >

EN840.3 containers (770-1300 litres)
by DIN pick up >

Set Lifting Capacity >

Weight >

Power source >

Electrical connections >

Hydraulic requirement >

Safety >

Noise level >

Painted finish >

70,000N (7,000kg)

15,000 N (1500 kgs) with all options fitted

Hydraulic & Electric





24VDC, 5A

ideally 40 ltr/min., maximum 60 ltr/min., 200 bar

New Market

<65db (A)

RAL Color as standard

Bin Type	Standard	Defined Lifting Capacity	Cycle Time (up/down sec.)
 2-wheel	EN 840-1	160 kg	3 + 7.5 / 7.5 + 3
 4-wheel flat lid	EN 840-2	800 kg (comb) 800 kg (pick-up arms)	7.5 / 7.5
 4-wheel dome lid	EN 840-3	800 kg (pick-up arms)	7.5 / 7.5
 Pocket arms 2.5/4.5 cbm	EN 12574-1	2000 kg	7.5 / 7.5
 Skip 5-10m ³	DIN 30 720	7000 kg	21 / 23

The electrical & hydraulic specifications listed above represent the most common configurations. However, certain chassis/body combinations may require these to be modified, Terberg should always be consulted before any preparation work commences

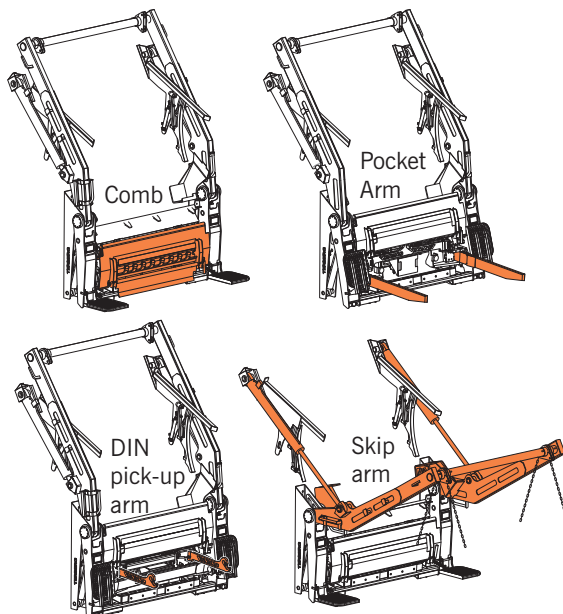
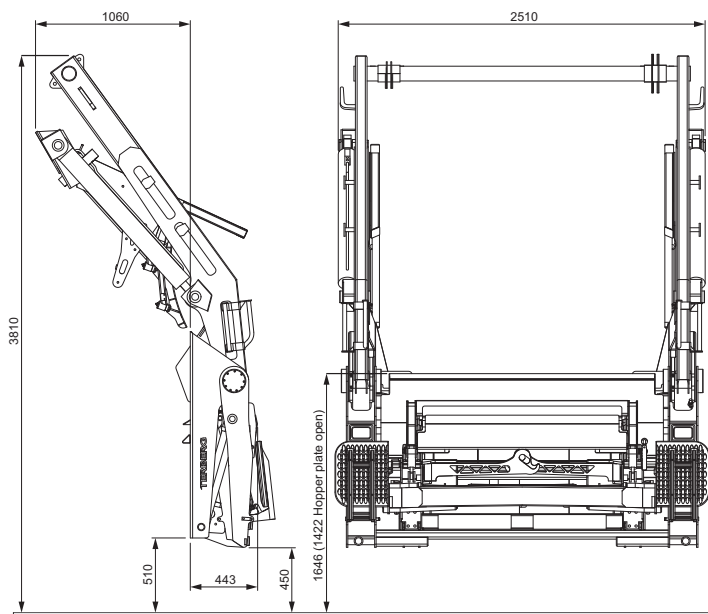

Terberg Machines B.V. reserve the right to change the specification or design of our equipment at any time without prior notification



Terberg Machines B.V, Postbus 127,
3400 AC IJsselstein (U), Holland.
Tel > (31) 30 2100 600
Fax > (31) 30 2100 610
E-mail: info@terbergmachines.nl

www.terbergmatec.com

OmniGV - Rev. 3 EN INTL - July 2019

